



Inductive sensor NJ40+U1+E2-T-V1

- 40 mm non-flush
- Extended temperature range



Dimensions

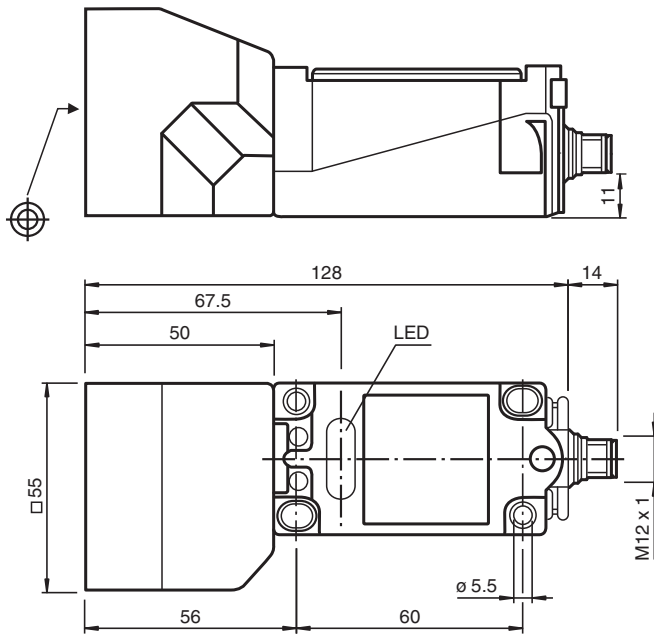

Technical Data

General specifications

Switching function		Normally open (NO)
Output type		PNP
Rated operating distance	s_n	40 mm
Installation		non-flush
Output polarity		DC
Assured operating distance	s_a	0 ... 32.4 mm
Reduction factor r_{Al}		0.4
Reduction factor r_{Cu}		0.3
Reduction factor r_{304}		0.85

Release date: 2022-05-18 Date of issue: 2022-05-18 Filename: 196264_eng.pdf

Refer to "General Notes Relating to Pepperl+Fuchs Product Information".

Pepperl+Fuchs Group
www.pepperl-fuchs.com

USA: +1 330 486 0001
fa-info@us.pepperl-fuchs.com

Germany: +49 621 776 1111
fa-info@de.pepperl-fuchs.com

Singapore: +65 6779 9091
fa-info@sg.pepperl-fuchs.com

PEPPERL+FUCHS

Technical Data

Output type		3-wire
Nominal ratings		
Operating voltage	U_B	10 ... 60 V
Switching frequency	f	0 ... 300 Hz
Hysteresis	H	typ. 3 %
Reverse polarity protection		reverse polarity protected
Short-circuit protection		pulsing
Voltage drop	U_d	≤ 3 V
Operating current	I_L	0 ... 200 mA
No-load supply current	I_0	≤ 20 mA
Time delay before availability	t_v	≤ 20 ms
Operating voltage indicator		LED, green
Switching state indicator		LED, yellow
Compliance with standards and directives		
Standard conformity		
Standards		EN 60947-5-2:2007 IEC 60947-5-2:2007
Approvals and certificates		
UL approval		cULus Listed, General Purpose
CSA approval		cCSAus Listed, General Purpose
Ambient conditions		
Ambient temperature		-25 ... 100 °C (-13 ... 212 °F)
Mechanical specifications		
Connection type		4-pin, M12 x 1 connector
Housing material		PBT
Sensing face		PBT
Degree of protection		IP68
Mass		130 g

Connection

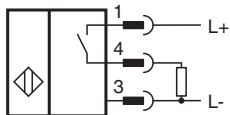

Connection Assignment

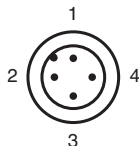





Connection Assignment

Wire colors in accordance with EN 60947-5-2

1	BN	(brown)
2	WH	(white)
3	BU	(blue)
4	BK	(black)

Accessories

	MHW 01	Modular mounting bracket
	MH 04-2681F	Mounting aid for VariKont, +U1+ and +U9*
	V1-W-2M-PUR	Female cordset single-ended M12 angled A-coded, 4-pin, PUR cable grey
	V1-G-2M-PUR	Female cordset single-ended M12 straight A-coded, 4-pin, PUR cable grey